

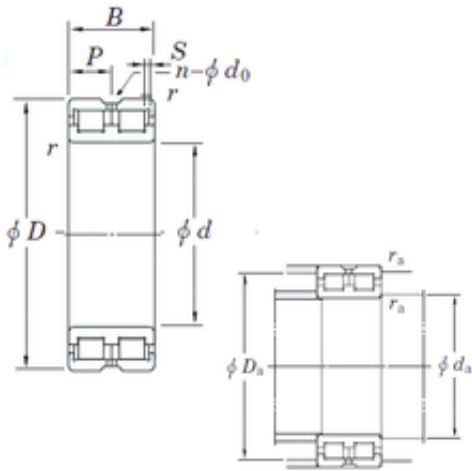

RAG Driveshaft USA CORP.



DC4976VW KOYO Full complement cylindrical roller bearings

Bearing No. DC4976VW

DC4976VW Bearing 2D drawings and 3D CAD models

Size	380x520x140 mm
Bore Diameter	380 mm
Outer Diameter	520 mm
Width	140 mm
d	380 mm
D	520 mm
B	140 mm
C	140 mm
n	8 mm
p	70 mm
r min.	4 mm
S	7 mm
da min.	398 mm
Da max.	502 mm
ra max.	3 mm
Weight	92,3 Kg
Basic dynamic load rating (C)	2 290 kN
Bearing No.	DC4976VW
r(min)	4
Cr	2290
C0r	5600
S	7 mm
P	70
n(qty)	8
do	8



RAG Driveshaft USA CORP.

da(min)	398
Da(max)	502
ra(max)	3
(Refer.)Mass(Fixed side)(kg)	90.5